

13772

[mm]

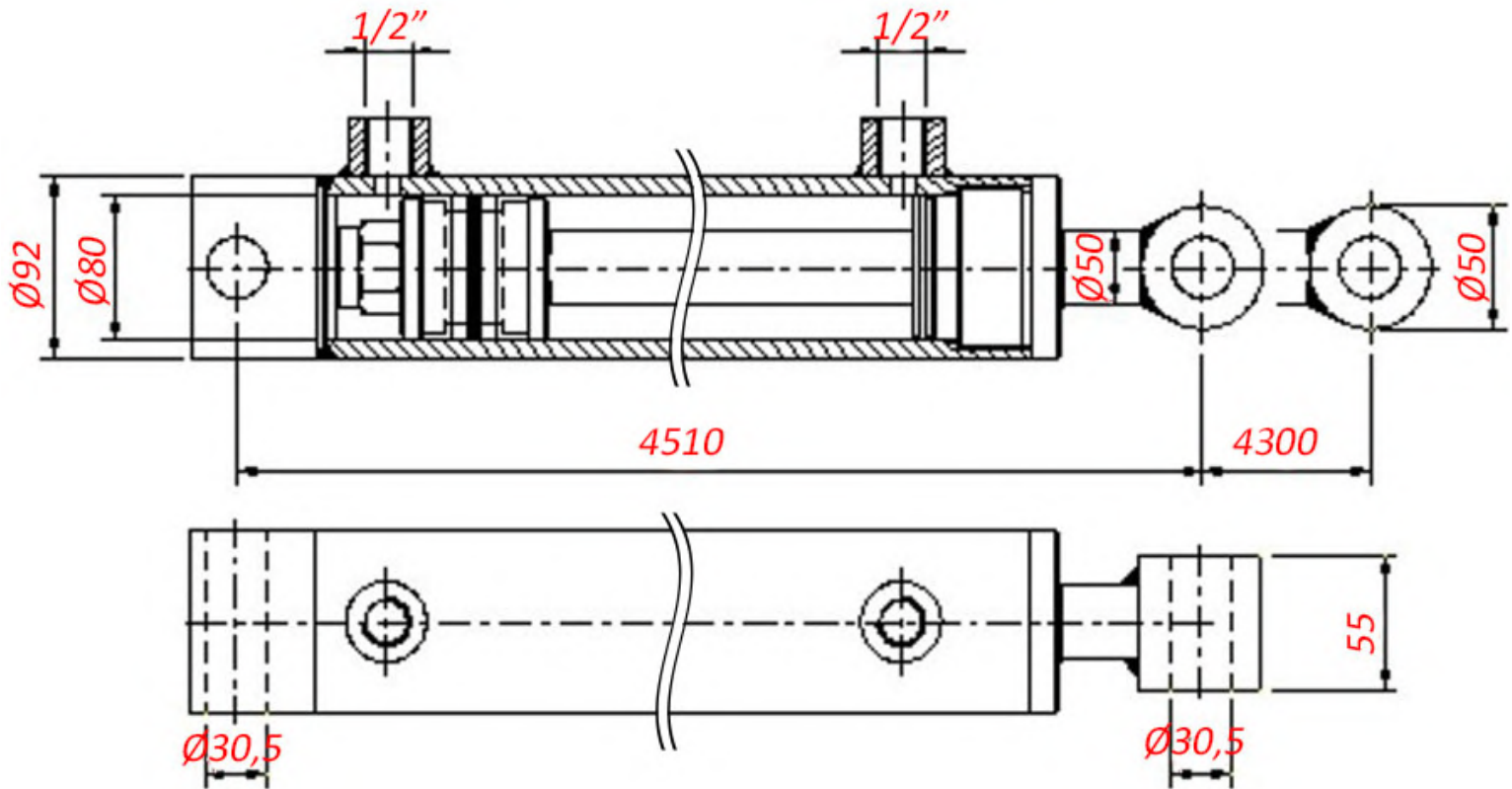

Šifra / Code		13772
Sila raztegovanja cilindra (250 bar) / Stretching force	[t]	12,56
Sila raztegovanja cilindra (180 bar) / Stretching force	[t]	9,04
Max. Tlak / Max. Pressure	[bar]	250
Max. Hitros / Max. Speed	[m/s]	0,5
Sila krčenja cilindra (250 bar) / Shrinkage force	[t]	7,65
Sila krčenja cilindra (180 bar) / Shrinkage force	[t]	5,51